

50 A externally operated series multiple (dual voltage) switches



General

Eaton connects primary windings with its Cooper Power™ series 50 A externally operated single-phase under-oil series multiple switches used either in series for a higher winding ratio or in parallel for a lower winding ratio.

This versatility allows one transformer to be stocked that can be used at either of two system voltages. This minimizes inventory and eases voltage conversion. Time-consuming manual voltage changeovers inside the transformer tank are also eliminated.

The 50 A switches may be used for 2:1 or lower voltage ratios only. Typical voltage ratios include:

2400 x 4800	7200 x 11430
4160 x 7200	7200 x 13200
4160 x 7620	7200 x 13800
4800 x 7200	7200 x 14400
4800 x 7620	7620 x 13200
4800 x 7970	7620 x 14400

Series multiple switches are designed for use in distribution transformers filled with transformer oil, Envirotemp™ FR3™ Fluid or an approved equivalent. The switch body, rotor and shaft are made of high strength glass-filled thermoplastic material. The operating shaft is sealed against leakage by high temperature resistant Viton® O-rings. Built-in internal stops ensure proper contact positioning between settings.

EATON

Powering Business Worldwide

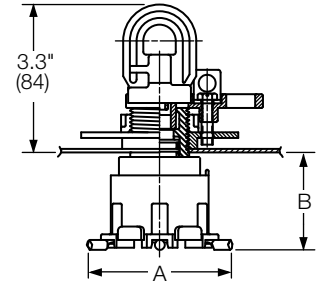
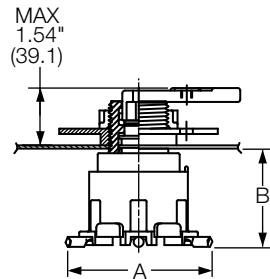
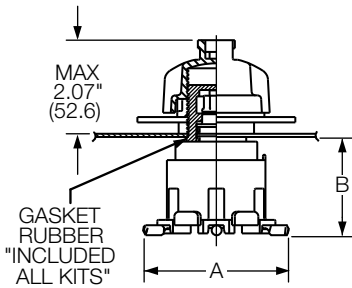
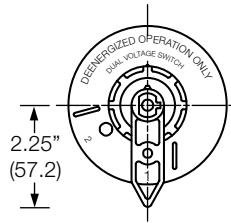
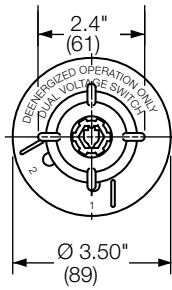

Figure 1. Switch with cap/wrench configuration.

Figure 2. Switch with lever handle configuration.

Figure 3. Switch with flexible, padlockable hotstick handle.

Note: A and B dimensions are listed in Table 3.

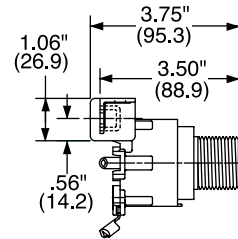
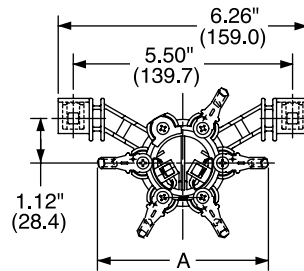
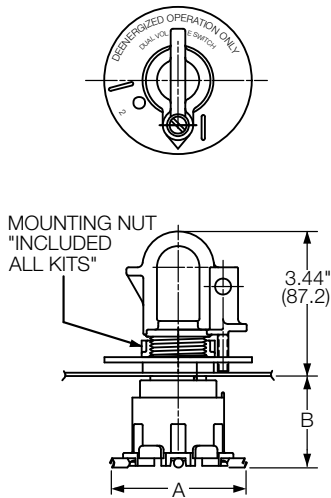

Figure 5. Switch with terminal posts.

Figure 4. Switch with one piece rigid thermoplastic, padlockable, hotstick handle.

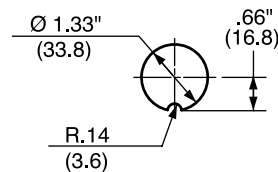

Figure 6. Mounting hole.

Handle options

Handle options include a cap/wrench, 2.25" lever (metal or thermoplastic), and hotstick operable. The cap/ wrench features a white arrow inside the handle for position indication, and has a one-way-in/one-way-out operating feature that ensures positive operation. The threaded cap protects the shaft seal from contamination. The lever handle has an indexing screw to ensure complete, positive switch contact. The lever handle can be ordered with an optional padlockable feature. The hotstick handle is available in flexible, multi-piece, or rigid, one-piece configurations, with padlockable option available. (See Table 4 for a complete listing.)

Stationary contacts

For ease of connection, bolt tab, bolt tab with 1/4-20 stud, 14-16 AWG, 10-12 AWG, or 8 AWG crimp terminals are available. (See Table 4 for a complete listing.)

Installation

No special tools are required. The switch body is installed through a keyed 1.33 inch (34 mm) hole in the tank wall and sealed by an inside gasket. An outer sealing nut is tightened to a torque of 80 to 120 in-lbs. Refer to *Service Information S800-70-1 50 A 2:1 Series Multiple (Dual Voltage) - Cap/Wrench, Lever or Hotstick Operable Handles Installation Instructions* for details.

Table 1. Voltage Ratings and Characteristics

Description	kV
Standard Voltage Class	25 Max.
ac 60 Hz 1 Minute Withstand	40
BIL and Full Wave Crest (in both series and parallel positions)	125

Voltage ratings and characteristics are in accordance with IEEE Std C57.12™ standard.

Table 2. Current Ratings and Characteristics

Description	Amperes
Continuous	50 A rms series position 100 A rms parallel position

Current ratings and characteristics are in accordance with IEEE Std C57.12™ standard.

Table 3. Switch Dimensions

Contact Type	"A" Dia.	"B" Dim
Bolt Tabs 90° Bend	2.91" 74.0 mm	2.81" 71.4 mm
14-16 AWG Long Shank 10-12 AWG Long Shank 8 AWG Long Shank	4.20" 106.7 mm	2.18" 55.4 mm
Three 14-16 AWG Long Shank and Two 90° Bolt Tab Three 10-12 AWG Long Shank and Two 90° Bolt Tab Three 18 AWG Long Shank and Two 90° Bolt Tab	2.91" 73.9 mm	2.81" 71.4 mm
Three 14-16 AWG Long Shank and Two Straight Bolt Tab Three 10-12 AWG Long Shank and Two Straight Bolt Tab Three 8 AWG Long Shank and Two Straight Bolt Tab	4.47" 113.5 mm	2.18" 55.4 mm
.25-20 Stud 90°	4.07" 103.3 mm	2.81" 71.4 mm
.25-20 Stud 45°	4.52" 114.8 mm	2.18" 55.4 mm

Ordering information

To order a 50 A series multiple switch, specify catalog numbers for one switch and one hardware kit.

Table 4. Series Multiple Switches

Contact Type	Catalog Number
Bolt Tabs 90° Bend ¹	2237501C01
14-16 AWG Long Shank (L.S.)	2237501C10
10-12 AWG Long Shank (L.S.)	2237501C11
8 AWG Long Shanks	2237501C12
Three 14-16 AWG Long Shank and Two 90° Bolt Tabs ¹	2237501C13
Three 10-12 AWG Long Shank and Two 90° Bolt Tabs ¹	2237501C14
Three 8 AWG Long Shank and Two 90° Bolt Tabs ¹	2237501C15
Three 14-16 AWG Long Shank and Two Straight Bolt Tabs ¹	2237501C16
Three 10-12 AWG Long Shank and Two Straight Bolt Tabs ¹	2237501C17
Three 8 AWG Long Shank and Two Straight Bolt Tabs ¹	2237501C18
Bolt Tab Bent 90° w/1/4 Inch Stud	2237501C60
Bolt Tab Bent 45° w/1/4 Inch Stud	2237501C61

Notes:

1. Recommended for applications that require a multiple lead connection.
2. For 2 or 3 deck versions, contact factory for details.
3. For optional switch with terminal posts, contact factory for details.

Table 5. Hardware Kits

Hardware Kits	Catalog Number
Cap/Wrench Combination Handle	2237947A40H
Cap/Wrench Combination Handle with Index Plate	2237947A45H
Metal Lever Handle	2237947A38H
Padlockable Metal Lever Handle	2237947A43H
Thermoplastic Lever Handle, 2.25 Inch with Index Plate, Position (1-2)	2237947A160H
Thermoplastic Lever Handle, 2.25 Inch with Metal Padlockable Clip, Index Plate, Position (1-2)	2237947A228H
One Piece, Rigid, Thermoplastic Padlockable, Hotstick Operable Handle, Position (1-2)	2237947A300H

Notes:

1. Standard Index Plate features a "1" and a "2". Index Plates with specific voltage designations are available upon request.
2. For Hardware Kits 2237947A38H, A43H, A45H, A160H, A228H, and A300H. If Index Plates With Specific Voltages (IE: 2400 x 4800, 7200 x 13,800) are Required, Reference Drawing 4200744N. (For Copies of This Drawing, Contact Factory.)

Eaton
1000 Eaton Boulevard
Cleveland, OH 44122
United States
Eaton.com

Eaton's Cooper Power Systems Division
2300 Badger Drive
Waukesha, WI 53188
United States
Eaton.com/cooperpowerseries

© 2015 Eaton
All Rights Reserved
Printed in USA
Publication No. CA800006EN



Eaton and Cooper Power are valuable trademarks of Eaton in the U.S. and other countries. You are not permitted to use these trademarks without the prior written permission of Eaton. IEEE Std C57.12 standard is a trademark of the Institute of Electrical and Electronics Engineers, Inc., (IEEE). This publication/product is not endorsed or approved by the IEEE. Envirotemp™ and FR3™ are licensed trademarks of Cargill, Incorporated. Viton® is a registered trademark of E.I. DuPont Demours & Company.

For Eaton's Cooper Power series dual voltage switches product information call 1-877-277-4636 or visit: www.eaton.com/cooperpowerseries.